







13 801 845



- saillie 210 mm
- jet normal circulaire
- diamètre de percement 37 mm
- raccord 1/2"
- montage de la fiche
- débit d'eau maxi. 21,5 l/min avec une pression d'écoulement de 3 bars

	Chrome	13 801 845-00
	Platine brossé	13 801 845-06
	Dark Chrome	13 801 845-19
	Noir mat	13 801 845-33
	Chrome brossé	13 801 845-93
	Dark Platinum brossé	13 801 845-99

Accessoires recommandés



- Coude mural à encastrer -** 35 085 970 90
- profondeur de montage max. 163 mm
 - profondeur de montage mini. 90 mm

13 801 845

mm [inches]



Diagramme de débit



Certificats

IAPMO_4976 (6). LGA_29012. WRAS_2207003.

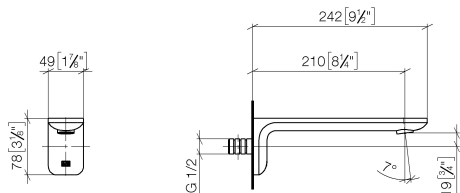
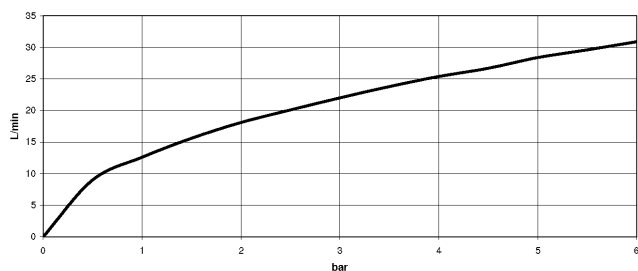
13 801 845

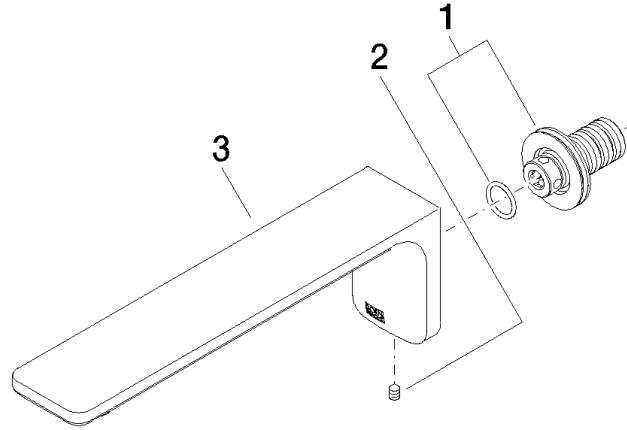

Liste des pièces de rechange

N°	Article Numéro	Désignation	Fréquence de montage	Délai de livraison
1	90 24 03 108 00 90	set deraccord à vis	1	2
2	90 31 11 004 00 90	tige	1	2
3	90 11 84 014 02-00	bec déverseur	1	10